

ULTRAFLEX COMMERCIAL GRADE 24V LED NEON

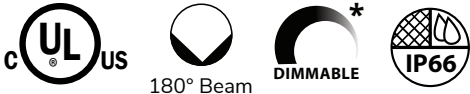

*If dimming, Lumenstar LED Neon must be used with Lumenstar certified Dimmable Power supplies

For indoor or outdoor use, available in 24V with six color options. Use 24V neon with Lumenstar's low voltage power supplies for maximum impact for up to 10M lengths.

Features

- Weather sealed for outdoor use
- Eco-friendly UV protected silicone
- Saltwater resistant
- V-2 Flame resistance
- 24V DC input
- Maximum length : 10M (32.8') with single side power
- Cutable every 2" (50mm)
- If dimming, Lumenstar LED Neon must be used with Lumenstar certified Dimmable Power supplies

Applications

Outdoor | Cove | Display & Accent | Perimeter & Architectural | Signage

Installation

Via mounting clips, aluminum mount with clips, or 1M aluminum channel with clips

Specifications

Voltage	24V DC
Wattage	2.9W/ft (9.6W/M)
Roll Length	32.8' (10M) - Custom lengths available up to 100' (30M)
Cut Distance	2" (50mm)
Color Temp	2700K / 3000K / 3500K / 4000K / 6500K / Yellow / Orange / Red / Green / Blue
Working Temp	-25~+60°C (-13~140°F)
IP Rating	66
CRI	>85
Lumen Output	178/ft (585/M)
Beam Degree	180°
Dimmable	Yes
Lifespan	+65,000 hours
Wire Length	3.28' (1M)
Warranty	3 Years

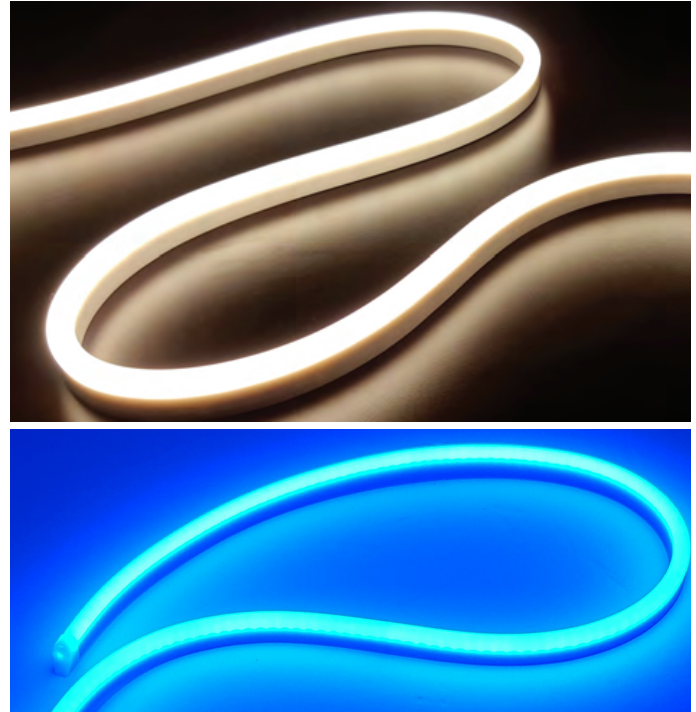

Dimensions

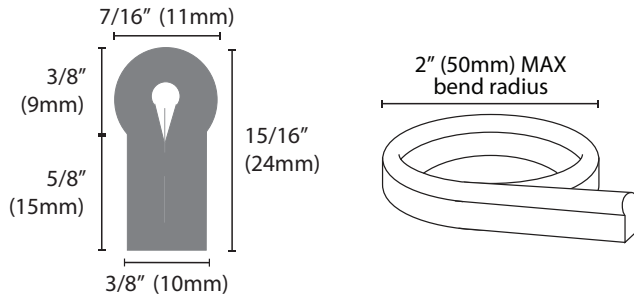

Ordering Codes

Product	Voltage	Length	Color Temp	
LS - <input type="text" value="NF"/>	- <input type="text" value="24"/>	- <input type="text" value="10"/>	-	
NF : Neon Flex	24 : 24 volts	10 : 10M (32.8')	27K : 2700K	3K : 3000K
		C : Custom Length	35K : 3500K	4K : 4000K
			65K : 6500K	R : Red
			G : Green	B : Blue
			Y : Yellow	O : Orange

Note : Power exit feeds orientations can be end exit or bottom exit.

Sample Neon

Image	Code	Product	Description
	LS-NF-24-2FT-XX <small>XX= Color Temperature</small>	2FT Sample Neon	Available in Warm White 2700K, Natural White 4100K, Cool White 6500K, Red, Green, Blue and RGB. Custom color temperature also available.



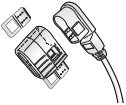
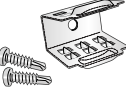
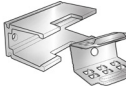
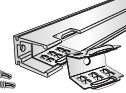

Accessories

Image	Code	Product	Description
	LS-NF-EC	End Caps	End cap without hole for 24V Neon.
	LS-NF-IC	Inline Connector	Inline connector for 24V Neon.
	LS-NF-CC	Corner Connector	Corner connector for 24V Neon.
	LS-NF-EEPF	Power Feed Inline	Power plug, inline feed for 24V Neon.

More Accessories

Image	Code	Product	Description
	LS-NF-BEPF	Power Feed Bottom	Power plug, bottom feed for 24V Neon.
	LS-NF-SLMC	Clip	Hardware mounting clips for 24V Neon. L20 x W15 x H11mm.
	LS-NF-MC	Aluminum Mount with Clip	35mm aluminum mount with hardware mounting clips for 24V Neon. L35 x W15 x H21mm
	LS-NF-AP	Aluminum Channel with Clips	1M Aluminum profile with x3 clips for 24V Neon. L1000 x W15mm

Power Supplies

Non-Dimmable					
Image	Code	Voltage	Output Power	Class II	Dimmable Specs
	LS-24V-60W-O-CV	24V	Max. 60W	√	N/A
	LS-24V-96W-O-CV	24V	Max. 96W	√	N/A
	LS-24V-150W-O-CV	24V	Max. 150W	x	N/A
	LS-24V-240W-O-CV	24V	Max. 240W	x	N/A
	LS-24V-320W-O-CV	24V	Max. 320W	x	N/A
Dimmable					
	LS-24V-60D-MLT-CV	24V	Max. 60W	√	Triac/Phase. 0-10V, 1-10V, Potentiometer, 10V PWM 5 in 1 dimming
	LS-24V-96D-MLT-CV	24V	Max. 96W	√	Triac/Phase. 0-10V, 1-10V, Potentiometer, 10V PWM 5 in 1 dimming
	LS-24V-150D-MLT-CV	24V	Max. 150W	X	
	LS-24V-300D-MLT-CV	24V	Max. 300W	X	