

CHROMALUX RGBW LED WALL WASHER



Suitable for architectural and landscape applications. Choose from millions of colors with this new high output **RGBW LED Wall Washer**

Features

- For indoor and outdoor use
- Super bright waterproof RGBW LED Wall Washer
- Includes DMX outdoor rated cable input and output with integrated 120V line

Operation

Can be operated in one of three ways:

- 1) **Independent Mode:** via onboard control (standalone operation)
- 2) **DMX Mode** International Standard DMX 512 signal (IP67 connector)
- 3) **Daisy Chain:** Master/repeater mode



Applications

Architectural | Billboards | Facade | Perimeters

Specifications

Voltage	110-277V AC
Wattage	65W
Lumens	3400
Color Temp	RGBW (3000K)
CRI	>80
Lifespan	+50,000 hours
Beam Angle	15° x 55° (custom 10°/30°/60°)
Working Temp	-20~+40°C (-4~104°F)
IP	65
Housing	Aluminum Alloy
Wire Length	60" (1.5M)
Warranty	3-year

Housing



Black

Dimensions

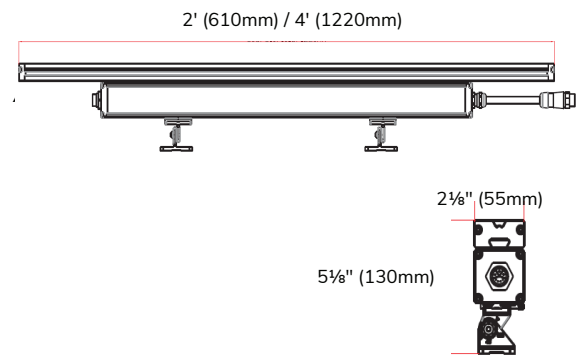







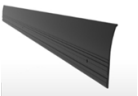

Ordering Codes

Product	Color Temp	Length	Finish
LS- <input type="text" value="WW2"/>	- <input type="text" value="RGBW"/>	- <input type="text" value="48"/>	- <input type="text" value="BK"/>
WW2: Wall Washer	RGBW: Multi-color + 3000K	48: 48" (1220mm)*	BK: Black

*Custom lengths available

Accessories

Image	Product	Code	Description
	Extension Brackets	LS-EB-BK	12" Extension Brackets
	Grille Cover	LS-GC-BK	Black Grille Cover
	Light Barrier	LS-LB-BK	Black Light Barrier
	5M Extension Cable	LS-5M-DMX-EXT	5M (16.4') DMX extension cable, outdoor rated connections
	30M (100') Extension Cable	LS-30M-DMX-EXT	30M (100') DMX extension cable, outdoor rated connections
	DMX WiFi Controller	LS-DMX-WC-RGBW	With pre-programmed modes and built-in WiFi router, the RGBW DMX controller provides full control and customization of your lighting experience. <i>Review spec sheet for more information.</i>
	100' Outdoor Wire	LS-OW-16-2-100	Outdoor wire for led lights. 16-2 AWG
	Outdoor Rated Marettes	LS-GEL-MAR	Outdoor rated, gel filled marettes ensure secure electrical connections in outdoor and wet conditions. Pack of 2.

Illuminance at a Distance

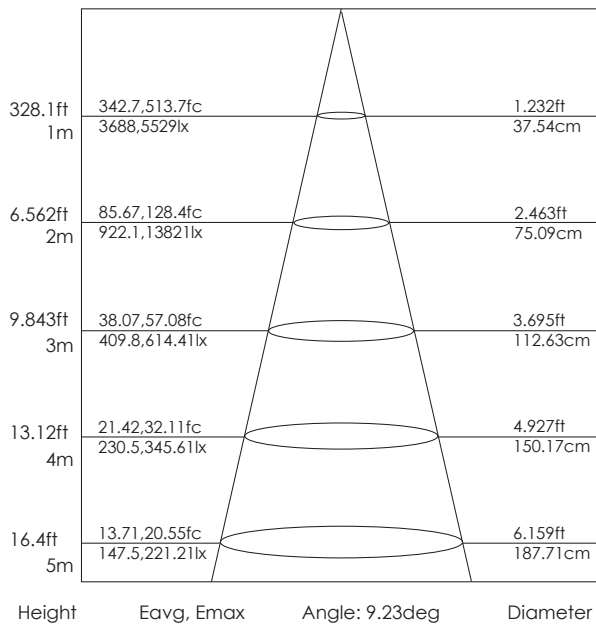

Note: The curves indicate the illuminated area and the average illumination when the luminaire is at a different distance.