

LUMIX COMMERCIAL GRADE LED BRICK LIGHT



120-277V AC LED brick light. ETL / cETL listed and IP67 rated, fully sealed for outdoor wet location installations.

Features

- Fully sealed for outdoor wet applications
- Recessed mount
- Die-cast zinc aluminum housing
- Zinc magnesium trim with powder coated finish
- Available trims: Screwless, Recessed and Louver

Applications

Deck | Step | Path | Architectural | Wall

Includes

LED light engine with gasket

Installation

Recessed housing size:

W6-3/4" (171mm) x D3-1/8" (80mm) x H3-1/8" (80m)



3-part System

Rough in Housing (back box), light engine, trim and install accessories are all ordered separately.

Finishes Available

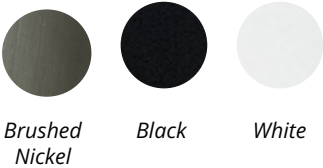

The rough in housing contains three 1/2" NPS knockouts with plugs

Specifications

Voltage*	100-277V AC (In-stock) ³Dimmable 120V AC (available on request)
Wattage	5W
Lumen Output	365
Color Temp**	3000K / 4000K
CRI	>90
Lifespan	+50,000 hours
Beam Angle	120°
Working Temp	-30~+45°C (-22~113°F)
IP Rating	67
Wire Length	12" (30cm)
Housing	Die-cast zinc magnesium

²Custom Colors are available:
2700K / 3500K / 5000K / Amber (Turtle Friendly)
— 10 Piece MOQ Required for Custom Colors

Dimensions

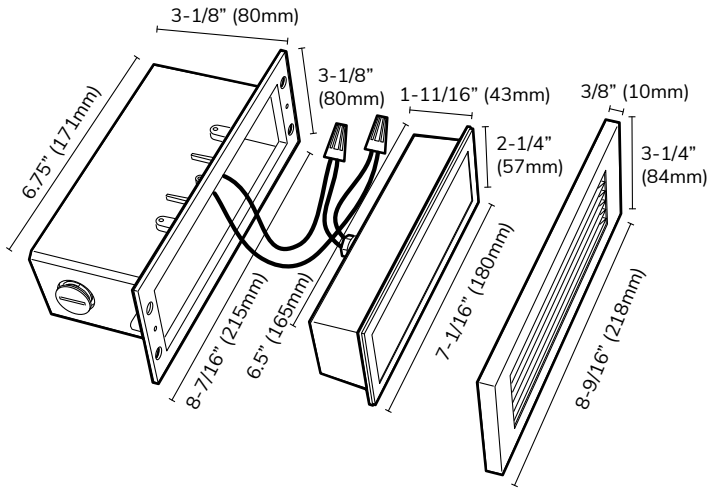

ORDERING CODES

Housing, light engine and trims sold separately.

³Rough In Housing Code:

Item
 LS - RT06 -
 HSG : Housing

Louver & Window Brick Light Engine³

Color Temp
 LS - -
¹In Stock ¹3K : 3000K ¹4K : 4000K
²27K : 2700K ²35K : 3500K
²5K : 5000K ²A : Amber

¹3K and 4K are stocked. All other colors available on custom order

³Dimmable 120V AC is available on request

Trim Code:

Trim Style	Finish
LS - RT06- <input type="text"/>	- <input type="text"/>
SLV : Screwless Louver	BN : Brushed Nickel
SW : Screwless Window	BK : Black
	WT : White

Recessed Brick Light Engine³

Color Temp
 LS - -
¹In Stock ¹3K : 3000K ¹4K : 4000K
²27K : 2700K ²35K : 3500K
²5K : 5000K ²A : Amber

Trim Code:

Trim Style	Finish
LS - RT06 - <input type="text" value="SRH"/>	- <input type="text"/>
SRH : Screwless Recessed	BN : Brushed Nickel
	BK : Black
	WT : White

¹3K and 4K are stocked. All other colors available on custom order

Louver & Window Trims

Can only be used with RTO6HV Light Engine for Louver & Window Brick Lights.







Product	Code	Finish	Description
	LS-RT06-SLV-BN	Brushed Nickel	Horizontal Louver trim, H3 ^{1/4} x W8 ^{9/16} " (H84 x W218mm)
	LS-RT06-SLV-BK	Black	Horizontal Louver trim, H3 ^{1/4} x W8 ^{9/16} " (H84 x W218mm)
	LS-RT06-SLV-WT	White	Horizontal Louver trim, H3 ^{1/4} x W8 ^{9/16} " (H84 x W218mm)
	LS-RT06-SW-BN	Brushed Nickel	Window trim, H3 ^{1/4} x W8 ^{9/16} " (H84 x W218mm)
	LS-RT06-SW-BK	Black	Window trim, H3 ^{1/4} x W8 ^{9/16} " (H84 x W218mm)
	LS-RT06-SW-WT	White	Window trim, H3 ^{1/4} x W8 ^{9/16} " (H84 x W218mm)

Recessed Horizontal Trims

Can only be used with RTO6HV-RV Light Engine for Recessed Brick Light.

Product	Code	Finish	Description
	LS-RT06-SRH-BN	Brushed Nickel	Screwless recessed trim, H3 ^{1/4} x W8 ^{9/16} " (H84 x W218mm)
	LS-RT06-SRH-BK	Black	Screwless recessed trim, H3 ^{1/4} x W8 ^{9/16} " (H84 x W218mm)
	LS-RT06-SRH-WT	White	Screwless recessed trim, H3 ^{1/4} x W8 ^{9/16} " (H84 x W218mm)

Accessories

Image	Product	Code	Description
	Rough in Housing	LS-RT06-HSG	Black Junction Box with three 1/2" NPS knockouts with plugs. L87/16 x H31/8 x W31/8" (L215 x W80 x H80mm)
	Masonry Bracket Set	LS-RT06-BKT	Used to mount the light into brick and other masonry surfaces.
	Stud Mounting Bracket & Bar	LS-RT06-STD	Used for mounting the light.
	Drywall Spring Clips	LS-RT06-CLP	Used to mount the light into drywall.
	100' Outdoor Wire	LS-OW-16-2-100	Outdoor wire for led lights. 16-2 AWG
	Outdoor Rated Marettes	LS-GEL-MAR	Outdoor rated, gel filled marettes ensure secure electrical connections in outdoor and wet conditions. Pack of 2.

